



SONICS[®]
SONICS & MATERIALS, INC.



vibra  **cell**[™]



ULTRASONIC LIQUID PROCESSORS

Introducing the VCX 500 and VCX 750

Simply stated... the VCX 500 and VCX 750 set the standard as the most technologically advanced and reliable ultrasonic processors in the industry.

POWERFUL

PRECISE

USER FRIENDLY



- Exclusive energy (Joules) monitor and controller
- Digital wattmeter
- Integrated temperature controller
- Intuitive usability
- Smallest footprint in the industry
- 3-year transferable warranty for parts **and** labor
- Designed and manufactured in the USA
- Used in more laboratories worldwide than any other ultrasonic processors

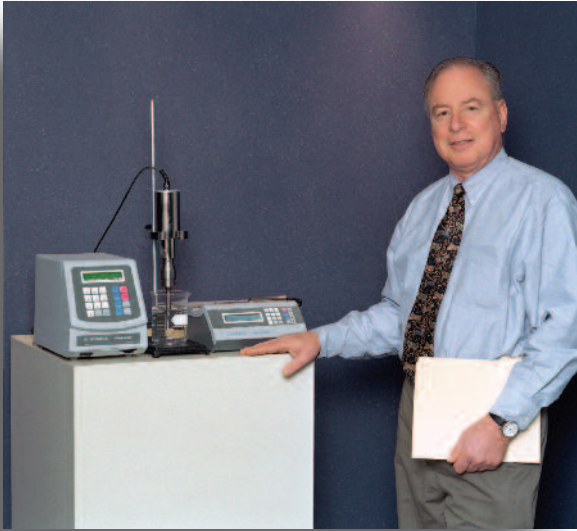

Dear Colleague

At Sonics, we believe that technological innovation and collaboration are the cornerstones on which to build a better product. We are research driven, and continually refine and broaden our product line by aggressively investing in R&D and working closely with laboratory and production personnel around the globe. The instruments displayed in this catalog are the product of that synergy.

On behalf of all of us at Sonics, I would like to take this opportunity to thank each and every one of our customers for their trust in our ability to meet their needs. We sincerely appreciate your loyalty and continued support.

Robert Soloff – President

General information and warranty1 and 2
 Ultrasonic processors for small volume applications3 and 4
 Optional accessories for small volume applications5 and 6
 Ultrasonic processors for small and medium volume applications7 through 10
 Optional accessories for small and medium volume applications11 through 17
 Ultrasonic processors and equipment for large volume applications18 through 20
 Ultrasonic equipment for sonochemistry21
 Ultrasonic atomizers22 through 24
 Ultrasonic processors for OEM applications25
 Frequently asked questions26
 Typical applications27

This catalog displays our products in terms of increasing power and processing capabilities, and includes, in addition to our standard line of ultrasonic equipment, a new generation of ultrasonic processors specifically designed to meet the diverse and evolving needs of our research and industrial customers.

OUR COMPANY PHILOSOPHY IS STRAIGHTFORWARD

- To be an innovative company that leads the industry with advanced ultrasonic solutions.
- To adhere to the highest standards of professional ethics.
- To offer the highest quality product at a fair price.

3-YEAR WARRANTY – UNLIKE ANY OTHER

The Vibra-Cell™ is the only ultrasonic processor that is backed by a three-year warranty that covers both parts **and** labor. In the unlikely event that your instrument should require servicing within that period, it will be repaired completely free of charge.



RELIABLE AND PREDICTABLE PERFORMANCE

To make sure that your ultrasonic processor will stand the test of time, we control the quality of our equipment by manufacturing many of our components in house. Our attention to details has contributed to a high degree of reliability, and over the years, the rate of return for units to be repaired has consistently been less than ¼ of 1%.



PERSONALIZED WORLDWIDE ASSISTANCE

For prompt technical support at the local level, Sonics has in place trained personnel located in most countries around the world.

For application-specific information, advice on which product to use, guidance prior to and during any phase of processing, or maintenance-related questions, please contact one of our Technical Support Specialists at our headquarters, or one of our authorized Vibra-Cell™ Distributors. Their experience with ultrasonic applications spans a broad spectrum of disciplines and functionalities, and they will provide you with a level of expertise and personalized service that is simply unmatched in the industry.

The Vibra-Cell™ is distributed in over 30 countries around the world. For the name of your local Distributor, please contact our corporate headquarters.

ABOUT ULTRASONICS

The ultrasonic power supply (generator) converts 50/60 Hz voltage to high frequency electrical energy. This alternating voltage is applied to disc-shaped ceramic piezoelectric crystals within the converter, causing them to expand and contract with each change of polarity. These high-frequency longitudinal mechanical vibrations are amplified by the probe (horn) and transmitted into the liquid as alternating expansive and compressive acoustic pressure waves. The pressure fluctuations cause the liquid molecule cohesive forces to break down, pulling apart the liquid and creating millions of micro-bubbles (cavities), which expand during the low pressure phases, and implode violently during the high pressure phases. As the bubbles collapse, millions of microscopic shock waves, micro jet streams, eddies and extremes in pressures and temperatures are generated at the implosion sites and propagated to the surrounding medium. Although this phenomenon, known as cavitation, lasts but a few microseconds, and the amount of energy released by each individual bubble is minimal, the cumulative amount of energy generated by the imploding cavities is extremely high and many times that generated in an ultrasonic bath.

When used with environmentally safe aqueous cleaning solutions, the Vibra-Cell™ becomes a powerful cleaning tool, capable of removing the most tenacious contaminants from normally inaccessible locations. Unlike ultrasonic baths, which dissipate the vibrational energy over a large area, the Vibra-Cell™ probe focuses the energy to create a concentrated, high intensity cleaning zone.

It should be noted that using a power supply of a higher power rating will not deliver more energy into the sample. Rather, it is the resistance to the movement of the probe that will determine how much power will be delivered. Negligible power is required to keep a probe vibrating in air. As the probe is immersed in a liquid and the resistance to its movement increases, a feedback network senses the change in power requirements, and causes the electrical power drawn from the power supply to increase automatically and proportionally in order to keep the amplitude at the probe tip constant. The higher the viscosity and greater resistance to the movement of the probe, the greater the amount of power that will be delivered to the probe.

***THE VIBRA-CELL™ INCORPORATES 50 YEARS OF INNOVATION TO DELIVER THE MOST ADVANCED
ULTRASONIC PERFORMANCE IN THE INDUSTRY.***

CUTTING-EDGE ULTRASONICS

Unlike conventional ultrasonic processors, the Vibra-Cell™ displays the amount of power in watts **and** the amount of energy in joules (watts x seconds). Additionally, the VCX 500 and VCX 750 provide a significant level of reproducibility by simultaneously monitoring **and** controlling both the temperature of the sample and the amount of energy that is being delivered. This innovation, available exclusively with the Vibra-Cell™, delivers unprecedented accuracy, and virtually eliminates any opportunities for human errors and operator-to-operator variability. In contrast to other ultrasonic processors, it is the only one that can control to one Joule, the amount of energy that is being delivered into the sample.

In order for a sample to be processed effectively, it is essential that the frequency and amplitude at the probe tip remains constant. Our Optotune™ amplitude control is unlike any other in the industry and incorporates proprietary digital circuitry that delivers exceptional stability, regardless of variations in density, viscosity, volume or temperature. Compared to other systems, the vibrations at the probe tip will not decrease as the resistance to the movement of the probe increases. With the Vibra-Cell™ critical protocols can be qualified and duplicated with confidence, knowing that the amplitude delivered will always be identical to the one specified.

All models are remote actuation compatible, and for greater reliability incorporate overload protection circuitry to shut down the ultrasonics in the event of out-of-spec processing. The converters are designed for heavy-duty operation, and are sealed for protection against potentially harmful contaminants.

Filtering complies with worldwide regulations governing RF interference and leakage current. For maximum economy all ½" (13 mm), ¾" (19 mm) and 1" (25 mm) probes are available with replaceable tips; when cavitation erosion is advanced, it is only necessary to replace the tip, not the probe (see caution on page 8). And because bench space is at a premium, the Vibra-Cell™ was designed with the smallest footprint in its class.

No other ultrasonic processor offers such levels of performance and reliability to give you the freedom to focus on what's important. In the lab and on the production line where processing capabilities and dependability are a prerequisite, the Vibra-Cell™ has no equal.

For Your Information . . . Power Ratings – Real or Exaggerated?

Unfortunately, there are no regulations governing ultrasonic processor power ratings.

One company may list its ultrasonic processor as being 100 watts, while another company, using the more stringent RMS rating standard will list that same unit as being only 60 watts.

With ultrasonic processing, the higher the wattage and the larger the probe diameter, the greater the volume that can be processed. Because power rating determinations vary widely with manufacturers, it is recommended that probe selection be carefully reviewed in order to ensure that the implied processing capabilities of the unit under consideration are valid. For example, a 100 watt unit should be able to drive a ½" (13 mm) probe, and **effectively** process up to 100 milliliters. If a ½" (13 mm) probe is not available with a "100 watt" unit, a method other than the RMS standard was used to determine its power rating, and its actual processing capabilities will be less than 100 ml.

Note: The maximum volume that can effectively be processed with a ⅛" (3 mm) probe is 15 ml.

At Sonics we use the RMS power rating standard and publish both the wattage **and** legitimate processing capabilities, for we think that giving one without the other would be both meaningless and intentionally misleading.



ULTRASONIC PROCESSORS FOR SMALL VOLUME APPLICATIONS

130 Watt Ultrasonic Processor with Thumb-actuated Pulsar or Footswitch
150 microliters to 150 milliliters

Real time display . . .



3 mm probe*



VCX 130 PB – VCX 130 FSJ

- Energy monitor
- Digital wattmeter
- Automatic tuning
- Automatic amplitude compensation
- Microprocessor based
- Thumb-actuated pulsar or footswitch
- Elapsed time indicator
- Variable power output control

SPECIFICATIONS

POWER SUPPLY

Net power output: 130 Watts. Frequency: 20 kHz
Dimensions: (H x W x D) 4½" x 9¾" x 12½" (115 x 250 x 320 mm)
Weight: 6.5 lbs. (3 kg)
Can be run continuously or in a pulsing mode**

CONVERTER

Piezoelectric lead zirconate titanate crystals (PZT)
Part No. CV 188 with pulsing button. Compatible with VCX 130 PB
Part No. CV 18 without pulsing button. Compatible with VCX 130 FSJ
Diameter: 1¼" (32 mm)
Length: 5¼" (146 mm)
Weight: ¾ lb. (340 g)
Cable length CV 18: 5' (1.5 m)
Cable length CV 188: 6' (1.8 m)

STANDARD PROBE

Tip diameter: ⅛" (3 mm). Processing capability: 250 µl to 10 ml.*
Length: 5⅞" (138 mm). Titanium alloy Ti-6Al-4V. Autoclavable. Part No. 630-0422

ELECTRICAL REQUIREMENTS

Unless otherwise requested, units are shipped wired for 117 volts, 50/60 Hz.
For export, please specify desired voltage option.

ORDERING INFORMATION

Model No.

130 Watt ultrasonic processor with pulsing buttonVCX 130 PB**
130 Watt ultrasonic processor with footswitchVCX 130 FSJ***

Shipped complete and ready for operation with a ⅛" (3 mm) probe, tool kit, and instruction manual.

OPTIONAL ACCESSORIES

For optional accessories, please refer to pages 5 and 6.

* A different probe can be substituted for the ⅛" (3mm) probe. For other volumes, please refer to probe and microtip listings on page 5.
** Model No. VCX 130 PB can not be used with a footswitch.
*** Model No. VCX 130 FSJ has a footswitch but the converter does not incorporate a pulsing button. Requires footswitch Part No. 830-00004 (included).

ULTRASONIC PROCESSORS FOR SMALL VOLUME APPLICATIONS

130 Watt Ultrasonic Processor with Timer and Pulser – 150 microliters to 150 milliliters

Real time display . . .

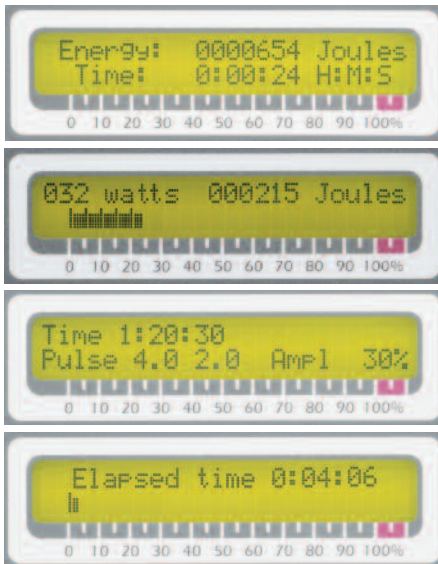

6 mm probe*



VCX 130

- Energy monitor
- Digital wattmeter
- Automatic tuning
- Automatic amplitude compensation
- Microprocessor based – programmable
- Ten hour timer
- 1-59 second independent ON/OFF pulser
- Elapsed time indicator
- Variable power output control

SPECIFICATIONS

POWER SUPPLY

Net power output: 130 Watts. Frequency: 20 kHz
 Dimensions: (H x W x D) 4½" x 9¾" x 12½" (115 x 250 x 320 mm)
 Weight: 7 lbs. (3 kg.)
 Timer: Variable from 1 second to 10 hours
 Pulser: On and Off cycle are independently controllable from 1 second to 59 seconds
 Remote actuation compatible. Footswitch compatible.**

CONVERTER

Part No. CV 18. Piezoelectric lead zirconate titanate crystals (PZT)
 Part No. CV 187. Same as CV 18 but with fittings for air cooling
 Diameter: 1¼" (32 mm)
 Length: 5¾" (146 mm)
 Weight: ¾ lb. (340 g)
 Cable length: 5' (1.5 m)

STANDARD PROBE

Tip diameter: ¼" (6 mm). Processing capability: 10 ml to 50 ml.*
 Length: 4½" (113 mm). Titanium alloy Ti-6Al-4V. Autoclavable. Part No. 630-0435

ELECTRICAL REQUIREMENTS

Unless otherwise requested, units are shipped wired for 117 volts, 50/60 Hz.
 For export, please specify desired voltage option.

ORDERING INFORMATION

Model No.

130 Watt ultrasonic processor VCX 130

Shipped complete and ready for operation with a ¼" (6 mm) probe, tool kit, and instruction manual.

OPTIONAL ACCESSORIES

For optional accessories, please refer to pages 5 and 6.

* A different probe can be substituted for the ¼" (6mm) probe. For other volumes, please refer to probe and microtip listings on page 5.

** Footswitch Part No. 830-00004.

STEPPED MICROTIPS AND PROBES

Microtips and probes amplify and radiate the ultrasonic energy into the sample. Smaller diameter tips produce greater intensity of cavitation, but the energy released is restricted to a narrower, more concentrated field. Conversely, larger diameter tips produce lower intensity, but the energy is released over a greater area permitting larger volume to be processed. Connecting stud 1/4 - 20. Microtips and probes are fabricated from titanium alloy Ti-6Al-4V and are autoclavable.

5/64" (2 mm) stepped microtip
Part No. 630-0423

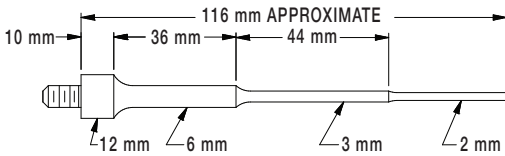

1/8" (3 mm) stepped microtip
Part No. 630-0422

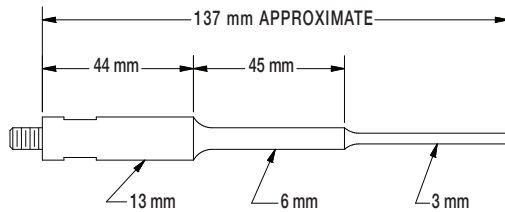

1/4" (6 mm) probe
Part No. 630-0435

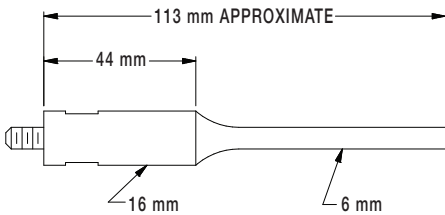

1/2" (13 mm) probe
Part No. 630-0561

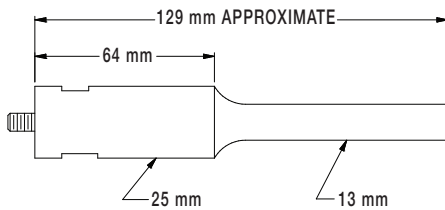

1/2" (13 mm) probe with replaceable tip*
Part No. 630-0560

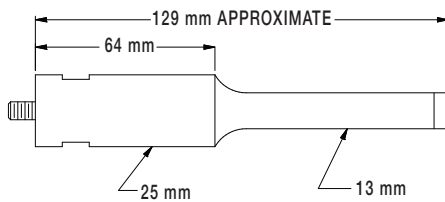

PART NO.	STEPPED MICROTIPS			PROBES
	630-0423	630-0422	630-0435	630-0561 630-0560**
TIP DIAMETER	5/64" (2 mm)	1/8" (3 mm)	1/4" (6 mm)	1/2" (13 mm)
INTENSITY	Ultra high	Very high	High	Medium
VOLUME (batch)	0.2 ml-5 ml	0.5 ml-10 ml	5-50 ml	50-150 ml
AMPLITUDE* micrometers (microns)	135	160	114	76
inches	.0050	.0060	.0045	.0030

*With the amplitude control set at 100%.

Note: With the amplitude control set at 100% the amplitude at the converter tip is 20 micrometers (.0008 inch). **With replaceable tip.

EIGHT-ELEMENT PROBE

The eight-element probe increases productivity and minimizes repetitive tasks by processing identically 8 samples simultaneously. Consists of an aluminum coupler and eight 1/8" (3 mm) mini microtips. Processing capabilities: 250 µl-2ml. Spacing between tips: 11/32" (9 mm). Mini microtip length: 11/16" (17 mm). Part No. 630-0602



REPLACEABLE TIP

The replaceable tip for probe Part No. 630-0560 is fabricated from titanium alloy Ti-6Al-4V and is autoclavable. Diameter: 1/2" (13 mm). Thread: 1/4 - 20 Part No. 630-0406



LOW VOLUME CONTINUOUS FLOW CELL **

The continuous flow cell screws into the converter in place of the probe. Recommended only for the treatment of low viscosity samples which do not require prolonged exposure to ultrasonics. Designed primarily for dispersing and homogenizing at rates up to 15 liters/hour. The cup is fabricated from glass. The probe and processing chamber are fabricated from titanium alloy Ti-6Al-4V and are autoclavable. Ease of disassembly facilitates cleaning. Volume of liquid with probe in place: 35 ml. Connecting stud: 1/4 - 20 Replacement glass chamber. Part No. 630-0565 Replacement probe. Part No. 630-0563 For low pressure applications only. Part No. 630-0566



NOTE: All probes and replaceable tips are fabricated from high grade titanium alloy Ti-6Al-4V and are autoclavable.

Because ultrasonic probes are tuned to resonance, their length may vary slightly due to variations in the titanium's modulus of elasticity.

* Do not use this probe with replaceable tip when processing samples containing organic solvents or low surface tension liquids. Use solid probe Part No. 630-0561 instead. See caution on page 8.

** Outlet connects to 1/2" (13 mm) I.D. tubing. Inlet connects to 3/8" (9.5 mm) I.D. tubing.

ROSETT COOLING CELL

The Rosett cooling cell enables uniform treatment at low temperatures. The cell is placed in a cooling bath. The ultrasonic energy forces the sample to circulate repeatedly under the probe and throughout the cooling arms.

30 ml Rosett cooling cell.
Part No. 830-00003



GLASS COOLING CELLS*

10 ml cooling cell with water jacket.
Part No. 830-00009

100 ml cooling cell with water jacket.
Part No. 830-00010

*Inlet and outlet require 3/8" (9.5 mm) I.D. tubing.

MICRO CUP HORNS*

The micro cup horns can process small samples in isolation without probe intrusion, precluding any possibilities of cross-contamination or aerosolization. Especially useful when working with infectious materials. Typical applications include: cell disruption, protein extraction, liposome preparation, protein shearing and releasing cellular components including DNA and RNA.

The water-filled micro cup horn screws into the inverted converter in place of a probe. The test tube containing the sample is placed inside the cup horn. The vibrations produced in the cup induce cavitation inside the tube. Inlet and outlet ports enable cooling water to be circulated within the cup, inhibiting heat build-up during extended operation. Ease of disassembly facilitates cleaning, and in contrast to polycarbonate cup horns with removable plastic fittings, is 100% leakproof. Supplied with splash shield.

Note: Because the intensity of cavitation within the test tube is substantially less than with direct probe contact, to obtain comparable results when using the cup horn, multiply the processing time by 4.

Probe: Titanium alloy Ti-6Al-4V. Connecting stud: 1/4" - 20. Diameter 25/32" (20 mm)

Glass vessel Inside diameter 1 1/2" (38 mm).

Part No. 630-0608

*Water inlet connects to 3/8" (9.5 mm) I.D. tubing. Water outlet connects to 1/2" (13 mm) I.D. tubing.



FOOTSWITCH

For hands-free operation
10' (3 m) cable with plug.
Part No. 830-00004



HANDHELD FREQUENCY METER

Check the frequency of energized probes, converters and boosters.

Frequency range: 10.00 kHz - 80.00 kHz

Part No. 833-00012



CONVERTER CLAMP

Securely supports 1 1/4" (32 mm) diameter converter on support stand with 1/2" (13 mm) diameter support rod. Chemical-resistant reinforced plastic.

Part No. 830-00118



SUPPORT STAND

Black enameled 5 1/2" x 9" (140 x 229 mm) cast-iron base and 1/2" (13 mm) diameter, 24" (610 mm) long zinc-plated rod.

Part No. 830-00109



SOUND ABATING ENCLOSURE

Even though ultrasonic vibrations are above the human audible range, ultrasonic processing produces a high pitched noise in the form of harmonics, which emanate from the vessel walls and the liquid surface. The sound abating enclosure permits extended processing without discomfort by reducing the sound by 35 db. The probe/converter assembly is supported by the converter clamp, and the converter cable is fed through the 3/4" (19 mm) opening at the top. Side access ports accommodate the tubing delivering the coolant and the sample to the processing vessel while the door is closed. The unit is faced on the exterior with white laminate, and lined on the interior with white waterproof polyethylene noise abating material. The transparent access door permits observation during treatment and protects the operator against accidental splashing. Support rod and converter clamp are included.

Outside dimensions: (H x W x D) 20" x 12" x 12" (510 x 300 x 300 mm).

Inside dimensions: (H x W x D) 17" x 9" x 9 1/2" (432 x 229 x 240 mm).

Part No. 630-0451



500 and 750 Watt Ultrasonic Processor – 250 microliters to 1 liter*

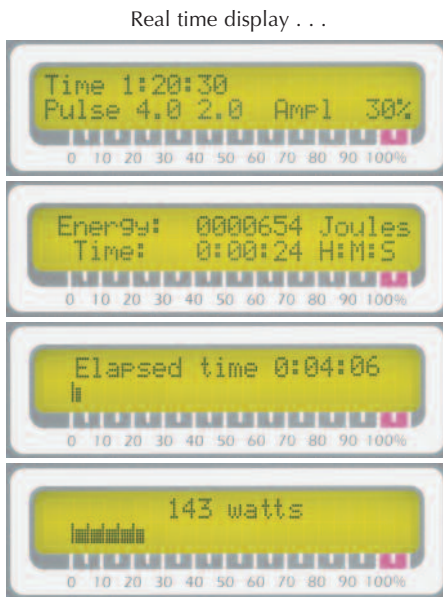

VC 505 – VC 750

- **Energy Monitor**
Digitally displays the actual amount of energy in Joules (watts x seconds) that is being delivered to the probe.
- **Wattmeter**
Digitally displays the actual amount of power in watts that is being delivered to the probe.
- **Automatic Tuning and Frequency Control**
Eliminates the need for constant adjustment of the power supply.
- **Microprocessor Based and Programmable**
Digital accuracy guarantees adherence to the most exacting protocol.
- **Automatic Amplitude Compensation**
Ensures uniform probe amplitude regardless of the varying loading conditions encountered during the processing cycle.
- **On Demand Real Time Display**
Provides a window on the process. No more assumptions. No more approximations. Pressing a button enables all set and run parameters to be continuously displayed on the screen, providing instant operating mode confirmation without process interruption.
- **Variable Power Output Control**
Allows the ultrasonic vibrations at the probe tip to be set to any desired amplitude. Selected output level is clearly displayed on the screen.
- **Ten Hour Process Timer**
Controls the processing time from 1 second to 10 hours.
- **Elapsed Time Indicator**
Monitors both the elapsed time and the duration of processing.
- **Independent On/Off Pulser**
Enables safe treatment of temperature-sensitive samples at high intensity, and provides mixing by repeatedly allowing the sample to settle back under the probe after each burst. Both on and off cycles are independently controllable from 1 second to 59 seconds.
- **User Friendly**
Menu driven fill-in-the-blank prompts provide intuitive guidance through all functions.
- **Smallest Footprint In Its Class**
Ultra-compact design eases emplacement and optimizes bench space. Only 7½" x 13½" (190 x 340 mm).

* For larger volumes use medium volume continuous flow cell Part No. 630-0651 or VCX 1500. Laboratory stand and converter clamp are not included.

SPECIFICATIONS

POWER SUPPLY	Net power output: VC 505 - 500 Watts. VC 750 - 750 Watts. Frequency: 20 kHz Remote actuation compatible. Dimensions: (H x W x D) 9¼" x 7½" x 13½" (235 x 190 x 340 mm) Weight: 15 lbs. (6.8 kg).
SEALED CONVERTER*	Part No. CV 334. Piezoelectric lead zirconate titanate crystals (PZT) Diameter: 2½" (63.5 mm) Length: 7¼" (183 mm) Weight: 2 lbs. (900 g)
CONVERTER CABLE	Cable length: 6' (1.8 m). Part No. 201-0300
STANDARD PROBE	Tip diameter: ½" (13 mm) with threaded end and replaceable tip Part No. 630-0220 or solid probe with non-replaceable tip Part No. 630-0219. Please specify** Processing capability: 50 ml to 250 ml.*** Length: 5¾" (136 mm) Weight: ¾ lb (340 g) Titanium alloy Ti-6Al-4V
TOOL KIT	Supplied with one open end wrench Part No. 888-00026, and one blue spanner wrench Part No. 888-00041 for the converter and one red spanner wrench Part No. 888-00042 for the probe.
ELECTRICAL REQUIREMENTS	Unless otherwise requested, units are shipped wired for 117 volts, 50/60 Hz. For export, please specify desired voltage option.

ORDERING INFORMATION

Model No.

500 Watt ultrasonic processor	VC 505
750 Watt ultrasonic processor	VC 750

Unless otherwise requested, shipped complete and ready for operation with a ½" (13 mm) probe with replaceable tip,** tool kit and instruction manual

OPTIONAL ACCESSORIES

For optional accessories, please refer to pages 11 through 17.

- * The converter incorporates two plugs which can be removed and replaced with barb fittings, to enable air cooling when the converter is operated at high amplitude for prolonged durations.
- ** Do not use a probe with replaceable tip when processing samples containing organic solvents or low surface tension liquids. See caution below. Use solid probe Part No. 630-0219 instead. Unless otherwise requested, the probe supplied will have a replaceable tip.
- *** For other volumes please refer to probe and microtip listings on pages 11 through 13. A different probe can be substituted for the ½" (13 mm) probe.

CAUTION

All probes, including those with replaceable tips, are tuned to resonate at 20 kHz. If the replaceable tip is removed or isolated from the rest of the probe, that element will no longer resonate at 20 kHz and the power supply will go into an overload condition and shut down or fail. Organic solvents (e.g., methylene chloride) and low surface tension liquids will penetrate the interface between the probe and the replaceable tip, thus carrying the particulates into the threaded section and isolating the tip from the probe. When processing samples containing organic solvents or low surface tension liquids, ALWAYS use a solid probe or as an alternate a full wave 10" (254 mm) probe or an extender. NEVER use a probe with a replaceable tip.

ULTRASONIC PROCESSORS FOR SMALL AND MEDIUM VOLUME APPLICATIONS

500 and 750 Watt Ultrasonic Processors – VCX Series – 250 microliters to 1 liter*

Real time display . . .

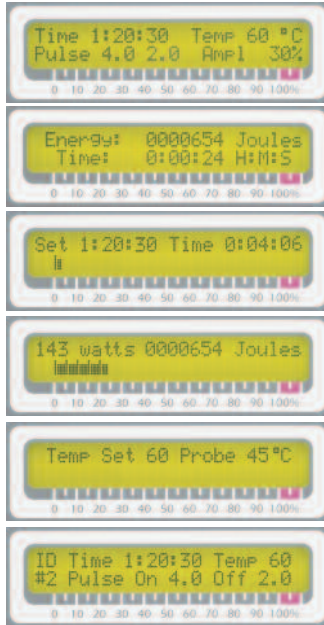

VCX 500 – VCX 750

- **Exclusive Energy Setpoint**
The energy setpoint continuously monitors the amount of energy in Joules (watts x seconds), that is being delivered to the probe, and terminates the ultrasonics when the desired amount of energy has been dispensed.
- **Wattmeter**
Digitally displays the actual amount of power in watts that is being delivered to the probe.
- **Automatic Tuning and Frequency Control**
Eliminates the need for constant adjustment of the power supply.
- **Integrated Temperature Controller**
Precludes harmful overheating of the sample and guarantees process integrity by terminating the ultrasonics when the sample temperature reaches a predetermined limit. Enables process control and monitoring from 1°C to 100°C.
- **Consistent Reproducibility**
Time-saving user-programmed presets store up to ten procedures to facilitate protocol duplication, automate repetitive tasks, and eliminate technician-to-technician method variability.
- **Microprocessor Based – Programmable**
Digital accuracy and repeatability guarantee adherence to the most exacting protocol.
- **Automatic Amplitude Compensation**
Ensures uniform probe amplitude regardless of the varying loading conditions encountered during the processing cycle.
- **On Demand Real Time Display**
Provides a window on the process. No more assumptions. No more approximations. Pressing a button enables all set and run parameters to be continuously displayed on the screen, providing instant operating mode confirmation without process interruption.
- **Variable Power Output Control**
Allows the ultrasonic vibrations at the probe tip to be set to any desired amplitude. Selected output level is clearly displayed on the screen.
- **Ten Hour Process Timer**
Controls the processing time from 1 second to 10 hours.
- **Elapsed Time Indicator**
Monitors both the elapsed time and the duration of processing.
- **Independent On/Off Pulsar**
Enables safe treatment of temperature-sensitive samples at high intensity, and provides mixing by repeatedly allowing the sample to settle back under the probe after each burst. Both on and off cycles are independently controllable from 1 second to 59 seconds.
- **User Friendly**
Menu driven fill-in-the-blank prompts provide intuitive guidance through all functions.
- **Smallest Footprint In Its Class**
Ultra-compact design eases emplacement and optimizes bench space. Only 7½" x 13½" (190 x 340 mm).

* For larger volumes use medium volume continuous flow cell Part No. 630-0651 or VCX 1500. Laboratory stand, converter clamp and temperature probe are not included.

SPECIFICATIONS

POWER SUPPLY	Net power output: VCX 500 - 500 Watts. VCX 750 - 750 Watts. Frequency: 20 kHz Remote actuation compatible Dimensions (H x W x D) 9¼" x 7½" x 13½" (235 x 190 x 340 mm) Weight: 15 lbs. (6.8 kg)
SEALED CONVERTER*	Part No. CV 334. Piezoelectric lead zirconate titanate crystals (PZT) Diameter: 2½" (63.5 mm) Length: 7¼" (183 mm) Weight: 2 lbs. (900 g)
CONVERTER CABLE	Cable length: 6' (1.8 m). Part No. 201-0300
STANDARD PROBE	Tip diameter: ½" (13 mm) with threaded end and replaceable tip Part No. 630-0220 or solid probe with non-replaceable tip Part No. 630-0219. Please specify** Processing capability: 50 ml to 250 ml.*** Length: 5⅝" (136 mm) Weight: ¾ lb. (340 g) Titanium alloy Ti-6Al-4V
TEMPERATURE PROBE (Optional)	Allows sample temperature to be monitored up to 100°C. Stainless steel. Part No. 830-00060
TOOL KIT	Supplied with one open end wrench Part No. 888-00026, and one blue spanner wrench Part No. 888-00041 for the converter and one red spanner wrench Part No. 888-00042 for the probe.
ELECTRICAL REQUIREMENTS	Unless otherwise requested, units are shipped wired for 117 volts, 50/60 Hz. For export, please specify desired voltage option.

ORDERING INFORMATION

Model No.

500 Watt ultrasonic processor	VCX 500
750 Watt ultrasonic processor	VCX 750

Unless otherwise requested, shipped complete and ready for operation with a ½" (13 mm) probe with replaceable tip,** tool kit, and instruction manual.

OPTIONAL ACCESSORIES

For optional accessories, please refer to pages 11 through 17.

* The converter incorporates two plugs which can be removed and replaced with barb fittings, to enable air cooling when the converter is operated at high amplitude for prolonged durations.
** Do not use a probe with replaceable tip when processing samples containing organic solvents or low surface tension liquids. See caution on page 8. Use solid probe Part No. 630-0219 instead. Unless otherwise requested, the probe supplied will have a replaceable tip.
*** For other volumes please refer to probe and microtip listings on pages 11 through 13. A different probe can be substituted for the ½" (13 mm) probe.

OPTIONAL ACCESSORIES FOR VC 505, VC 750, VCX 500 AND VCX 750

The accessories and attachments described in this section are compatible with most 20 kHz ultrasonic processors. Please specify make, model, and connecting stud size ($\frac{1}{2}$ " - 20 or $\frac{3}{8}$ " - 24) when ordering.

NO.	DESCRIPTION	PART NO.
1	Converter Part No. CV 334*	CV00334
2	Multi-element coupler	See page 14
3	$\frac{1}{8}$ " (3 mm) stepped microtip	See page 13
4	Booster	BHNVC21
5	$\frac{1}{2}$ " (13 mm) solid probe	630-0219
	$\frac{1}{2}$ " (13 mm) probe with threaded end and replaceable tip*	630-0220
	$\frac{3}{8}$ " (19 mm) solid probe	630-0208
	$\frac{3}{8}$ " (19 mm) probe with threaded and replaceable tip	630-0207
	1" (25 mm) solid probe	630-0209
	1" (25 mm) probe with threaded and replaceable tip	630-0210
6	$\frac{1}{2}$ " (13 mm) replaceable tip	630-0406
	$\frac{3}{8}$ " (19 mm) replaceable tip	630-0407
	1" (25 mm) replaceable tip	630-0408
7	Coupler	630-0421
	Reverse coupler	630-0613
8	$\frac{5}{16}$ " (2 mm) stepped microtip	630-0423
	$\frac{1}{8}$ " (3 mm) stepped microtip	630-0422
	$\frac{1}{8}$ " (3 mm) low amplitude tapered microtip	630-0718
	$\frac{1}{4}$ " (6 mm) probe	630-0435
9	$\frac{1}{2}$ " (13 mm) probe with threaded end and replaceable tip	630-0220
10	$\frac{3}{8}$ " (19 mm) tapered microtip	630-0418
	$\frac{3}{16}$ " (5 mm) tapered microtip	630-0419
	$\frac{1}{8}$ " (6 mm) tapered microtip	630-0420
11	Probe – solid or with threaded end and replaceable tip – same as 5	
12	Replaceable tip – same as 6	
13	$\frac{1}{2}$ " (13 mm) half wave extender 5" (127 mm) long	630-0410
	$\frac{3}{8}$ " (19 mm) half wave extender 5" (127 mm) long	630-0409
	1" (25 mm) half wave extender 5" (127 mm) long	630-0444
14	$\frac{3}{8}$ " (19 mm) solid high gain probe	630-0306
	1" (25 mm) solid high gain probe	630-0310
15-16	$\frac{1}{2}$ " (13 mm) full wave probe solid 10" (254 mm) long	630-0217
	$\frac{1}{2}$ " (13 mm) full wave probe 10" (254 mm) long with threaded and replaceable tip	630-0218
17	Aluminum coupler*	630-0562
18	$\frac{3}{8}$ " (19 mm) solid probe	630-0208
19	2 $\frac{3}{4}$ " (70 mm) inside diameter cup horn	630-0431
20	$\frac{1}{2}$ " (13 mm) solid probe with flange at the nodal point	630-0603

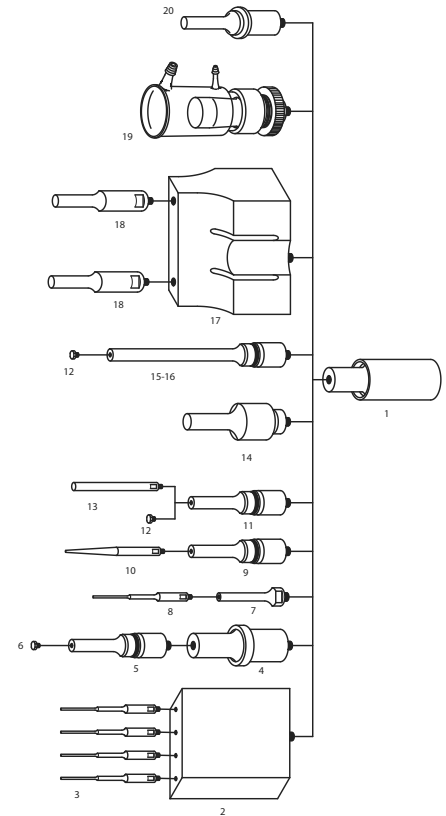

* Supplied with standard equipment unless otherwise specified.

Caution: Do not use a tapered microtip with a coupler. Do not use a stepped microtip without a coupler. Observe microtip amplitude limits. Do not use a probe with threaded end and replaceable tip when processing samples containing organic solvents or low surface tension liquids. Use a solid probe instead. See caution on page 8.

PROBES

Probes (sometimes referred to as horns) are one-half wavelength long tools that act as mechanical transformers to increase the amplitude of vibration generated by the converter. They consist of two sections each having different cross-sectional areas. When driven at its resonant frequency, the probe expands and contracts longitudinally about its center. However, no longitudinal motion occurs at the threaded nodal point (area of no activity), allowing accessories to be connected to the probe at that point. The greater the mass ratio between the upper section and the lower section, the greater the amplification factor, and the greater the peak-to-peak excursion at the tip of the probe. Probes with smaller tip diameters produce greater intensity of cavitation, but the energy released is restricted to a narrower, more concentrated field. Conversely, probes with larger tip diameters produce less intensity, but the energy is released over a greater area. The larger the tip diameter, the larger the volume that can be processed, but at lower intensity. High gain probes produce higher intensity than standard probes of the same diameter, and are usually recommended for processing difficult applications. Probes are fabricated from high grade titanium alloy Ti-6Al-4V because of its high tensile strength, good acoustical properties at ultrasonic frequencies, high resistance to corrosion, low toxicity, and excellent resistance to cavitation erosion. They are autoclavable, and available with threaded ends to accept replaceable tips, microtips and extenders.

PROBES*

PART NO.	630-0220**	630-0219	630-0207**	630-0208	630-0210**	630-0209
TIP DIAMETER	½" (13 mm)	½" (13 mm)	¾" (19 mm)	¾" (19 mm)	1" (25 mm)	1" (25 mm)
TYPE	Threaded End	Solid	Threaded End	Solid	Threaded end	Solid
INTENSITY	High	High	Medium	Medium	Low	Low
VOLUME (batch)	50-250 ml	50-250 ml	50-500 ml	50-500 ml	100-1000 ml	100-1000 ml
AMPLITUDE*** micrometers	114	114	58	58	35	35
inches	.0045	.0045	.0022	.0022	.0014	.0014
LENGTH†	5½" (139 mm)	5½" (139 mm)	5" (127 mm)	5" (127 mm)	4⅓" (122 mm)	4⅓" (122 mm)

* Connecting stud ½ - 20. Available with ¾ - 24 stud to enable connection to a 20 kHz converter manufactured by another company.

** Do not use a probe with a replaceable tip when processing samples containing organic solvents or low surface tension liquids. Use a solid probe instead. See caution on page 8.

*** With the amplitude control set at 100%.

† Because ultrasonic probes are tuned to resonance, their length may vary slightly due to variations in the titanium's modulus of elasticity.

Note: With the amplitude control set at 100%, the amplitude at the converter tip is .0006 inch (16.5 micrometers).



HIGH GAIN PROBES*

PART NO.	630-0306**	630-0310**
TIP DIAMETER	¾" (19 mm)	1" (25 mm)
TYPE	Solid	Solid
INTENSITY	High	Medium
VOLUME (batch)	50-500 ml	100-1000 ml
AMPLITUDE*** micrometers	120	70
inches	.0048	.0027
LENGTH†	5⅜" (137 mm)	5⅝" (133 mm)

* Connecting stud ½ - 20. Available with ¾ - 24 stud to enable connection to a 20 kHz converter manufactured by another company.

** Do not use with a booster.

*** With the amplitude control set at 100%.

† Because ultrasonic probes are tuned to resonance, their length may vary slightly due to variations in the titanium's modulus of elasticity.

Note: With the amplitude control set at 100%, the amplitude at the converter tip is .0006 inch (16.5 micrometers).

DUAL PROBE*

The dual probe assembly enables a single ultrasonic processor to process two (25-500 ml) samples simultaneously. The assembly consists of an aluminum coupler Part No. 630-0562 and two ¾" (19 mm) solid probes Part No. 630-0208.** Power delivered to each probe is identical, and is half the total power delivered by the power supply. Center to center dimension between the probes is 4½" (114 mm).

Connecting stud ½ - 20.*** Part No. 630-0525

When used with a 750 watt ultrasonic processor, the dual probe is the only one in the industry capable of delivering up to 375 watts per probe, meeting all EPA requirements specified in SW-846 method 3550.



* Custom three and four-element probes are available upon request.

** Two ½" (13 mm) solid probes can be substituted for the two ¾" (19 mm) solid probes. Probes can also be supplied with threaded end and replaceable tip, however these probes should not be used when processing liquids containing organic solvents or low surface tension liquids. See caution on page 8.

*** Available with ¾ - 24 connecting stud to enable connection to a 20 kHz converter manufactured by another company.

BOOSTERS

Boosters are used to process difficult applications. When connected between the converter and the probe, the booster (also called amplitude transformer) acts as a mechanical amplifier that increases the amplitude of vibration at the probe tip.* Connecting stud ½ - 20. Length: 5" (129 mm).

Part No. BHNVC21. Increases the amplitude by a factor of 2.

*Do not use with a microtip, extender, dual probe, ½" (13 mm) step probes Part No. 630-0220 or 630-0219, or high gain probe.

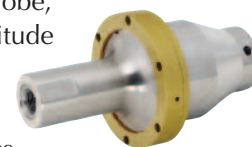

MICROTIPS

Two types of microtips are available to enable processing samples in small vessels at very high intensity – a tapered microtip and a stepped microtip.

The tapered microtip screws into the ½" (13 mm) threaded end probe in place of the replaceable tip.

The stepped microtip/probe assembly which consists of two parts, the coupler (standard or reverse) and the microtip or probe*, screws into the converter in place of the probe. Capable of reaching into narrower vessels than the tapered microtip, the stepped microtip assembly can process volumes as small as 150 µl. Microtips are fabricated from titanium alloy Ti-6Al-4V and are autoclavable.

*Sold separately.

CAUTION: *In order not to exceed the tensile limit of the titanium, and causing the microtip to fracture, observe the maximum amplitude limits listed below.*



TAPERED MICROTIP

(see page 11)



COUPLER



STEPPED MICROTIP

(see page 11)

MICROTIPS

PART NO.	TAPERED MICROTIP*			STEPPED MICROTIP/PROBE ASSEMBLY**			
	630-0418	630-0419	630-0420	COUPLER*** 630-0421	STEPPED MICROTIP 630-0423	STEPPED MICROTIP 630-0422	PROBE 630-0435
TIP DIAMETER	⅛" (3 mm)	⅜" (5 mm)	¼" (6 mm)		⅛" (2 mm)	⅛" (3 mm)	¼" (6 mm)
INTENSITY	Ultra high	Very high	High		Ultra high	Very high	High
VOLUME (batch)	1-15 ml	3-20 ml	10-50 ml		0.2 ml-5 ml	0.5 ml-15 ml	5 ml - 50 ml
MAXIMUM AMPLITUDE	40%	65%	75%		40%	40%	40%
micrometers [†]	160	212	180		89	105	75
(microns)							
inches [†]	.0060	.0083	.0070		.0035	.0040	.0030
LENGTH [#]	6 ¹¹ / ₁₆ " (171 mm)	5 ²⁹ / ₃₂ " (150 mm)	5 ¹⁹ / ₃₂ " (142 mm)	3 ³ / ₄ " (95 mm)	4 ¹ / ₂ " (116 mm)	5 ¹³ / ₃₂ " (136 mm)	4 ⁷ / ₁₆ " (113 mm)

* Screws into a ½" (13 mm) threaded end probe Part No. 630-0220 in place of the replaceable tip. Connecting stud ¼ - 20. To process a sample below 20% use low amplitude tapered microtip Part No. 630-0718.

** Consists of coupler and stepped microtip or probe. Screws into the converter instead of the ½" (13 mm) probe. To process a sample below 20% use with reverse coupler Part No. 630-0613. The coupler and microtip are sold separately.

*** Connecting stud ½ - 20.

† With the amplitude control set at the maximum amplitude listed above.

Because microtips are tuned to resonance, their length may vary slightly due to variation in the titanium's modulus of elasticity.

EXTENDERS

Extenders screw into threaded end probes of identical diameter in place of the replaceable tip. Recommended when working with tall narrow vessels such as Erlenmeyer flasks. Extenders are fabricated from titanium alloy Ti-6Al-4V and are autoclavable. Also available on special order with threaded ends to accept replaceable tips.* Connecting stud ¼ - 20.

½" (13 mm) half wave extender - 5" (127 mm) long. Part No. 630-0410.

¾" (19 mm) half wave extender - 5" (127 mm) long. Part No. 630-0409.

1" (25 mm) half wave extender - 5" (127 mm) long. Part No. 630-0444.



* Do not use an extender with replaceable tip when processing samples containing organic solvents or low surface tension liquids. Use a solid extender instead. See caution on page 8.

Note: Because extenders are tuned to resonance, their length may vary slightly due to variations in the titanium's modulus of elasticity. Longer extenders are available upon request.

REPLACEABLE TIPS

Replaceable tips are fabricated from titanium alloy Ti-6Al-4V and are autoclavable.



REPLACEABLE TIPS

	1/2" (13 mm)	3/4" (19 mm)	1" (25 mm)
PART NO.	630-0406	630-0407	630-0408
CONNECTING STUD	1/4-20	3/8-24	1/2-20

MULTI-ELEMENT PROBES

The high throughput multi-element probes increase productivity and minimize repetitive tasks by processing identically numerous samples simultaneously. They screw into the converter in place of the standard 1/2" (13 mm) probe, and can be used either manually or with automated systems. The energy delivered by each tip is uniform within 2%. With the four, eight, and twenty four-element probes, the spacing between the tips (center to center) is 22/32" (18 mm) and the length of the special microtips is 5 7/16" (139 mm). With the twelve-element probe the spacing between tips (center to center) is 1" (25 mm) and the length of the probe is 5 13/32" (113 mm). With the ninety-six element probe, spacing between the tips (center to center) is 1 1/2" (9 mm) and the length of the mini microtips is 1 1/16" (17 mm). With the four, eight and twenty four-element probes, the diameter of the special microtips is 1/8" (3 mm). With the twelve-element probe, the diameter of the probe is 1/4" (6 mm). With the ninety-six element probe the diameter of the mini microtip is 5/64" (2 mm). Multi-element probes are fabricated from titanium alloy Ti-6Al-4V and are autoclavable. Connecting stud 1/2 - 20. Available with 3/8 - 24 adapting stud to enable connection to a 20 kHz converter not manufactured by Sonics.

Note: Custom formatted multi-element probes are available upon request.

MULTI-ELEMENT PROBES

PART NO.	DESCRIPTION	ULTRASONIC PROCESSOR
630-0559	Four-element probe	500 / 750 watt and Sonifier 250 / 450 watt
630-0660	Consists of an aluminum coupler and four 1/8" (3 mm) special microtips. Replacement microtip (250 µl – 10 ml) for four-element probe	
630-0586	Eight-element probe	500 / 750 watt and Sonifier 250 / 450 watt
630-0660	Consists of an aluminum coupler and eight 1/8" (3 mm) special microtips. Replacement microtip (250 µl – 10 ml) for eight-element probe	
630-0646	Twelve-element probe	500 / 750 watt and Sonifier 250 / 450 watt
630-0435	Consists of an aluminum coupler and twelve 1/4" (6 mm) probes. Replacement probe (10 – 50 ml) for twelve-element probe	
630-0579	Twenty-four-element probe*	500 / 750 watt and Sonifier 250 / 450 watt
630-0660	Consists of an aluminum coupler and twenty-four 1/8" (3 mm) special microtips. Replacement microtip (250 µl – 10 ml) for twenty-four-element probe	
630-0611	Ninety-six-element probe*	500 watt or 750 watt
630-0599	Consists of an aluminum coupler and ninety-six 1 1/16" (17 mm) mini microtips. Replacement mini microtip (1 – 2 ml) for ninety-six-element probe	



*Not recommended for volumes smaller than 1 ml.

HEAVY DUTY MULTI-ELEMENT PROBE SUPPORT ASSEMBLY

Supports the converter and multi-element probe with minimum deflection. Recommended when working with twenty-four and ninety-six element probes. Base: 10" x 10" (254 x 254 mm). Height: 24" (610 mm). Part No. 830-00320



SOUND ABATING ENCLOSURE

Even though ultrasonic vibrations are above the human audible range, ultrasonic processing produces a high pitched noise in the form of harmonics which emanate from the vessel walls and the fluid surface. The sound abating enclosure permits extended processing without discomfort by reducing the sound by 35db. The probe/converter assembly is supported by the converter clamp, and the converter cable is fed through the $\frac{3}{4}$ " (19 mm) opening at the top. Side access ports accommodate the tubing delivering the coolant and the sample to the processing vessel while the door is closed. The unit is faced on the exterior with white laminate, and on the interior with white waterproof polyethylene noise abating material. The transparent access door permits observation during treatment and protects the operator against accidental splashing. Support rod and light duty converter clamp are included. Outside dimensions: (H x W x D) 30" x 14" x 14" (762 x 355 x 355 mm).

Inside dimensions: (H x W x D) 27" x 11" x 11" (686 x 280 x 280 mm).

Part No. 630-0427



LABORATORY JACK

Provides adjustable elevation from 2½" (64 mm) to 10" (254 mm).

Top plate: 6" x 5" (152 x 127 mm).

Part No. 830-00113



NON-SLIP VIBRATION ISOLATING MAT

Holds beakers and microplates securely in place, and reduces noise by absorbing vibrations normally transmitted to the laboratory jack.

4" x 7" (100 x 175 mm).

Part No. 830-00119



CONVERTER CLAMP

The converter clamp securely supports 2½" (64 mm) diameter converters onto stands with ½" (13 mm) diameter support rod.

Chemical-resistant reinforced plastic.

Part No. 830-00116



SUPPORT STAND

Black enameled cast-iron base and zinc-plated rod.

Base: 5½" x 9" (140 x 229 mm).

Rod: ½" (13 mm) diameter, 24" (610 mm) long.

Part No. 830-00109



HIGH INTENSITY CUP HORNS*

The cup horns can process samples in isolation without probe intrusion, precluding any possibilities of cross-contamination or aerosolization. Especially useful when working with infectious materials.

Typical applications include: cell disruption, liposome preparation, protein shearing, and releasing cellular components including DNA and RNA.

The water-filled cup horn is screwed into the inverted converter in place of the probe. The test tube(s) containing the sample(s) is(are) placed inside the cup horn. The vibrations produced in the cup induce cavitation inside the tube(s). Inlet and outlet ports enable cooling water to be circulated within the cup, inhibiting heat build-up during extended operation. Ease of disassembly facilitates cleaning, and in contrast to polycarbonate cup horns with removable plastic fittings, these cup horns are 100% leakproof. The probe is fabricated from titanium alloy Ti-6Al-4V and is autoclavable. The cup is fabricated from glass. Supplied with floating microtube holder Part No. 830-00238 to enable 8 samples to be processed simultaneously with identical parameters, and splash shield. Note: Because the intensity of cavitation within the test tube(s) is substantially less than with direct probe contact, to obtain comparable results when using the cup horn, multiply the processing time by 4. Connecting a booster Part No. BHNVC21 between the cup horn and the converter, will double the intensity of cavitation within the cup.***



PART NO.	OVERALL HEIGHT	OUTSIDE DIAMETER	INSIDE DIAMETER	PROBE DIAMETER	REPLACEMENT PROBE PART NO.	REPLACEMENT CUP PART NO.
630-0431	6" (152 mm)	3" (76 mm)	2 ³ / ₄ " (70 mm)	2" (51 mm)	630-0457	630-0438

* Connecting stud 1/2" - 20. Available on special order with 3/8" - 24 stud to enable connection to a 20 kHz converter manufactured by another company.

** Water inlet connects to 3/8" (9.5 mm) I.D. tubing. Water outlet connects to 1/2" (13 mm) I.D. tubing.

*** When using a booster, always increase the power supply amplitude gradually to inhibit stalling.

FLOATING MICROTUBE HOLDER

The plastic microtube holder conveniently suspends eight 1.5 ml microtubes inside the high intensity cup horn. Holder floats and keeps tubes immersed at a constant depth regardless of the fluctuation in water level. Pressure plate holds tubes firmly in place and keeps tube caps closed. Autoclavable. Microtubes not included.

Part No. 830-00238



MEDIUM VOLUME CONTINUOUS FLOW CELL*

The stainless steel continuous flow cell enables closed system operation and ensures safe processing when working with infectious materials. Recommended for the treatment of low viscosity samples, which do not require prolonged exposure to ultrasonics. Designed primarily for dispersing and homogenizing one or two dissimilar materials simultaneously at rates up to 30 liters/hour. Suitable for pressures up to 100 psi (690 kPa/6.9 bar). Volume of liquid in chamber with probe in place: 65 ml. Fittings require 5/16" (8 mm) ID tubing. Stainless steel. Autoclavable. Probe is included.

Part No. 630-0651

Note: For most applications the sample should be fed through the lower side port and collected at the bottom port. However it is recommended that for cell disruption, the flow be reversed. Use both inlets when processing two different materials simultaneously.

* Must be used with probe Part No. 630-0644.

Note: Inlet and outlet flow can be reversed if needed. The secondary inlet enables functionalizing agents to be added to the formation during processing, or used for monitoring the pressure.

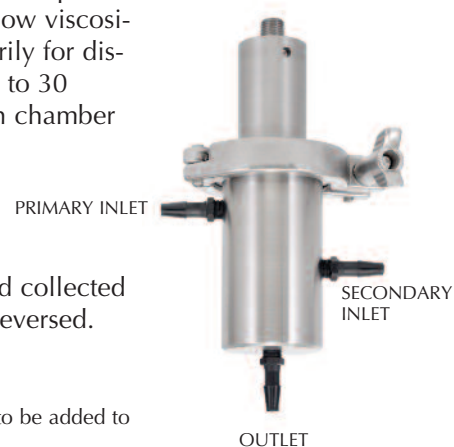

ROSETT GLASS COOLING CELLS

The Rosett cooling cell enables uniform treatment at low temperatures. The cell is placed in an ice bath. The ultrasonic energy forces the sample to circulate repeatedly under the probe and throughout the cooling arms.

30 ml Rosett cooling cell.
Part No. 830-00003

300 ml Rosett cooling cell.
Part No. 830-00001



GLASS COOLING CELLS*

10 ml cooling cell with water jacket.
Part No. 830-00009

100 ml cooling cell with water jacket.
Part No. 830-00010



*Inlet and outlet require $\frac{3}{8}$ " (9.5 mm) I.D. tubing.

FOOTSWITCH

For hands-free operation 10' (3 m) cable with plug.
Part No. 830-00004



TEMPERATURE PROBE*

Enables temperature monitoring from 1° to 100° C.
Part No. 830-00060

* For VCX models only.



ADAPTING STUD

$\frac{3}{8}$ -24 to $\frac{1}{2}$ -20

Enables a 20 kHz probe not manufactured by Sonics to be connected to our converter. The $\frac{3}{8}$ -24 connecting stud is removed from the probe and replaced with the adapting stud.
Part No. 631-0101



HANDHELD FREQUENCY METER

Check the frequency of energized probes, converters and boosters.
Frequency range: 10.00 kHz - 80.00 kHz
Part No. 833-00012



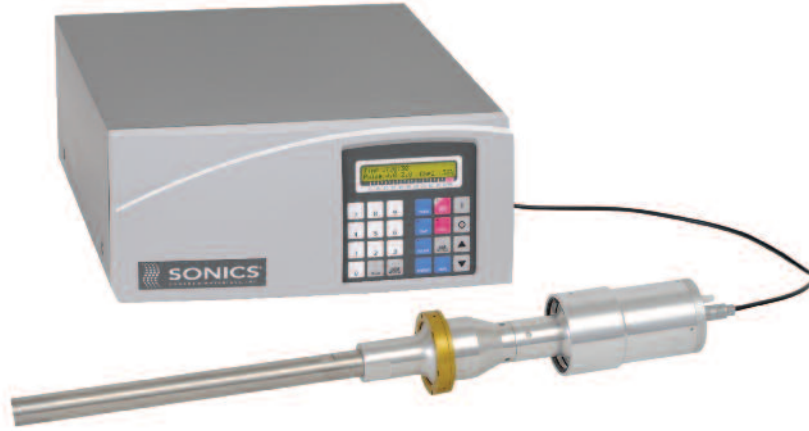

VCX 1500

- Same functions as VCX 750 (see page 9)
- Up to 20 liters on a batch basis*

SPECIFICATIONS

POWER SUPPLY	Net power output: 1500 Watts. Frequency: 20 kHz Dimensions (H x W x D): 7" x 15" x 18¼" (178 mm x 380 x 463.5 mm) Weight: 21 lbs. (9.5 kg)
AIR COOLED CONVERTER	Part No. CV 294. Piezoelectric lead zirconate titanate crystals (PZT) Diameter: 3" (76.2 mm) Length: 6¼" (158.7 mm) Weight: 2 lbs. (900 g)
CONVERTER CABLE	Cable length: 10' (3 m). Part No. 201-0106
BOOSTER	Part No. BHNVC21 – Increases the amplitude by a factor of 2 Length: 5" (129 mm)
STANDARD PROBE	Part No. 630-0617 Tip diameter: 1" (25 mm). Solid Length: 9" (230 mm) Weight: 1.5 lbs. (680 g) Titanium alloy: Ti-6Al-4V. Autoclavable Processing capabilities: 20 liters*
TOOL KIT	Supplied with two spanner wrenches Part No. 888-00015
ELECTRICAL REQUIREMENTS	220 volts, 50/60 Hz, single phase, 15A

ORDERING INFORMATION

	Model No.
1500 Watt ultrasonic processor	VCX 1500
Sound abating enclosure with solid door for VCX 1500..... (H x W x D) 36" x 16" x 16" (914 x 406 x 406 mm)	630-0474**
Support stand	830-00109
Converter clamp for VCX 1500	830-00120
Optional temperature probe	830-00060

* Up to 20 liters when used with a 1" (25 mm) solid 18½" (470 mm) long probe Part No. 630-0621, and a customer-supplied mechanical stirrer.

** The sound abating enclosure will accommodate the VCX 1500 converter, booster and 1" (25 mm) probe Part No. 630-0209, 630-0210 and 630-0310. It will not accommodate the 1" (25 mm) solid 18½" (470 mm) long probe Part No. 630-0621 because of its length.

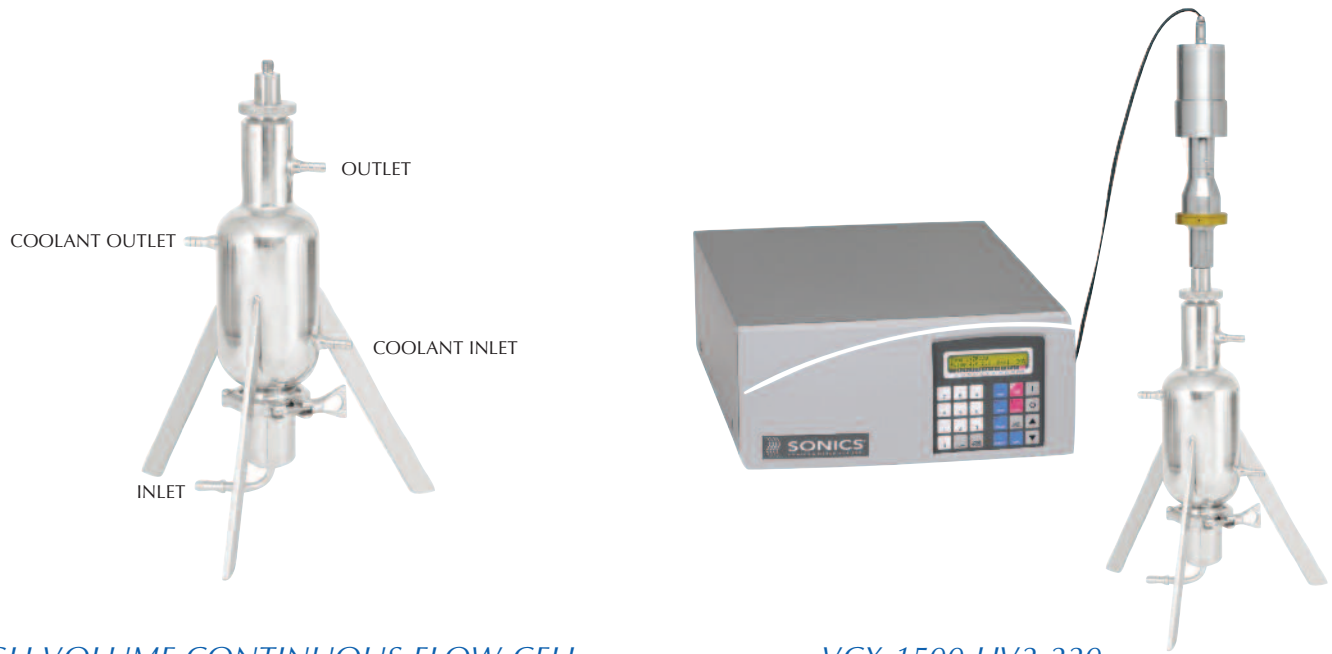

HIGH VOLUME CONTINUOUS FLOW CELL

VCX 1500 HV2-220

The flow cell throughput rate is typically 100 liters/hour – variables being viscosity and desired degree of processing. The flow cell is recommended for the treatment of low viscosity samples which do not require extended exposure to ultrasonics. Designed primarily for dispersing and homogenizing. For optimum performance, when working on a flow through basis, premixing the sample with a mechanical stirrer is recommended. The flow cell is easily disassembled for inspection and cleaning, and is water jacketed to enable the sample to be cooled/heated while it is being processed. All wetted parts are autoclavable.

SPECIFICATIONS

POWER SUPPLY	VCX 1500 HV2-220 (see page 18)
AIR COOLED CONVERTER	Part No. CV 294. Piezoelectric lead zirconate titanate crystals (PZT)
BOOSTER	Part No. BHNVC21. Increases the amplitude by a factor of 2.
HIGH VOLUME CONTINUOUS FLOW CELL	Weight: 12 lbs. (5.5 kg) Height: 19.6" (498 mm) Width: 15" (381 mm) Housing: 316 stainless steel. Quick opening clamp Probe: Solid – Part No. 630-0619 – Titanium alloy Ti-6Al-4V Operating pressure: Up to 50 psi (345 kPa/3.45 bar) Volume of liquid in chamber with probe in place: 500 ml. Tubing required: ¼" (6 mm) inside diameter Part No. 630-0683
TOOL KIT	Supplied with two spanner wrenches Part No. 888-00015

ORDERING INFORMATION

	<i>Model No.</i>
1500 Watt high volume ultrasonic liquid processing system	VCX 1500 HV2-220
Replacement solid probe for high volume continuous flow cell	630-0619
Sound abating enclosure for high volume continuous flow cell* (H x W x D) 36" x 16" x 16" (914 x 406 x 406 mm)	630-0474

* The sound abating enclosure will accommodate the booster and 1" (25 mm) probe Part No. 630-0209, 630-0210 and 630-0310. It will not accommodate the 1" (25 mm) solid 18½" (470 mm) long probes Part Nos. 630-0619, 630-0621, or 630-0631 due to their length.



VCX 2500

- Same functions as VCX 750 (see page 9)
- Up to 50 liters on a batch basis*

SPECIFICATIONS

POWER SUPPLY	Net power output: 2500 Watts. Frequency: 20 kHz Dimensions (H x W x D): 9.5" x 17.5" x 28" (240 mm x 445 x 711 mm) Weight: 48 lbs. (21.8 kg)
AIR COOLED CONVERTER	Part No. CV 294. Piezoelectric lead zirconate titanate crystals (PZT) Diameter: 3" (76.2 mm) Length: 6¼" (158.7 mm) Weight: 2 lbs. (900 g)
CONVERTER CABLE	Cable length: 10' (3 m). Part No. 201-0106
BOOSTER	Part No. BHNVC21 – Increases the amplitude by a factor of 2 Length: 5" (129 mm)
STANDARD PROBE	Part No. 630-0631 Tip diameter: 1.5" (38 mm). Solid Length: 14½" (370 mm) Weight: 2.2 lbs. (816 g) Titanium alloy: Ti-6Al-4V. Autoclavable Processing capabilities: 50 liters*
TOOL KIT	Supplied with two spanner wrenches Part No. 888-00015
ELECTRICAL REQUIREMENTS	220 volts, 50/60 Hz, single phase, 30A

ORDERING INFORMATION

	Model No.
2500 Watt ultrasonic processor	VCX 2500
Sound abating enclosure with solid door for VCX 2500..... (H x W x D) 36" x 16" x 16" (914 x 406 x 406 mm)	630-0474**
Support stand	830-00109
Converter clamp for VCX 2500	830-00120
Optional temperature probe	830-00060

* Up to 50 liters when used with probe Part No. 630-0631 and customer-supplied mechanical stirrer.

** The sound abating enclosure will accommodate the VCX 2500 converter, booster and 1" (25 mm) probe Part No. 630-0209, 630-0210 and 630-0310. It will not accommodate the 1" (25 mm) solid 18½" (470 mm) long probe Part No. 630-0621 because of its length.

The chemical effects of ultrasound are diverse and include dramatic improvements in both stoichiometric and catalytic reactions. In some cases, ultrasonic irradiation can increase reactivities by nearly a million-fold. It does so through the process of acoustic cavitation; the formation, growth and implosive collapse of bubbles in a liquid.

During cavitation collapse, intense heating of the bubbles occurs. The localized hot spots have temperatures in the range of 5000°C, pressures approaching 500 atmospheres, lifetimes of a few microseconds, and heating and cooling rates greater than 109 K/s.* Of special interest for sonochemistry research, is the fact that cavitation generates highly reactive free radicals that greatly enhance chemical reactions.

Applications for chemical reactions exist in both homogeneous liquids and in liquid-solid systems. Of special synthetic use is the ability of ultrasound to create clean, highly reactive surfaces on metals. Ultrasound has also been found to be beneficial for the initiation or enhancement of catalytic reactions, in both homogeneous and heterogeneous cases.

RECOMMENDED ULTRASONIC PROCESSOR

VC 505, VC 750, VCX 500 or VCX 750. Please see pages 9 and 10 for detailed description.

SONOCHEMICAL REACTION VESSELS

The adapter Part No. 830-00014 screws onto the special probe Part No. 630-0217 at the nodal point. The glass chamber slides onto the adapter and is secured in place as the bushing is screwed into the chamber compressing the O-ring. Moving the glass chamber up or down on the adapter allows the portion of the probe protruding out of the adapter to be immersed at the optimum depth into the sample.

4-10 ml reaction vessel.** Two 14/20 side necks. Supplied with bushing and O-ring. Glass chamber height: 4⁷/₈" (123 mm). Part No. 830-00011.

10-50 ml reaction vessel.** Bottom well capacity: 10 ml. Main body capacity: 50 ml. Two 14/20 side necks. Supplied with bushing and O-ring. Glass chamber height: 4³/₄" (120 mm). Part No. 830-00012.

40-250 ml reaction vessel.** Three 14/20 side necks. Supplied with bushing and O-ring. Glass chamber height: 6³/₈" (162 mm). Part No. 830-00013.

SPECIAL PROBE

½" (13 mm) special 10" (254 mm) long full wave solid probe. Used with the adapter below. Titanium alloy Ti-Al-4V. Autoclavable Part No. 630-0217.

ADAPTER

5" (127 mm long). Stainless steel. Internally threaded. Screws onto a full wave 10" (254 mm) long ½" (13 mm) probe at the nodal point. Part No. 830-00014.

* From an article by Dr. Kenneth Suslick, Professor of Chemistry and Beckman Institute Professor, University of Illinois Urbana/Champaign.

** Must be used with the adapter Part No. 830-00014 and probe Part No. 630-0217 listed above.



3-10 ml Vessel
830-00011



10-50 ml Vessel
830-00012



40-250 ml Vessel
830-00013



Adapter
830-00014

ULTRASONIC ATOMIZERS

Low and Medium Atomization Rate – 40 kHz

- From microliters to liters – continuous or intermittent
- Dispenses material with negligible overspray
- Pressureless atomization – low velocity mist
- Low cost atomizing probe replacement
- Minimal atmospheric contamination
- Virtually uncloggable



VCX 134 ATDP – 40 kHz*

TYPICAL APPLICATIONS

- Coating non-woven fabric, paper, etc.
- Laboratory spray drying
- Injecting moisture into a gas stream
- Applying minute amount of oil, fragrance or flavor onto a product

GENERAL DESCRIPTION

Unlike conventional atomizing nozzles that rely on pressure and high-velocity motion to shear a fluid into small drops, the ultrasonic atomizer uses only ultrasonic vibrational energy to generate a gentle, low-velocity spray. Overspray is practically eliminated, resulting in substantial material savings and reduction in airborne pollution. The liquid can be dispensed to the atomizing probe (nozzle) by either gravity or a small low-pressure metering pump, and atomized continuously or intermittently. The rate at which the liquid is atomized depends, within limits, solely on the volume that is being delivered onto the atomizing surface, and the frequency. Typically, the higher the frequency, the lower the processing capability. The amount of material atomized can be as little as 2 $\mu\text{l}/\text{sec}$. Because the droplets typically drift downward at low velocity under the influence of gravity, the probe should be mounted with the tip facing downward, and air turbulence kept to a minimum to mitigate spray pattern distortion. Low velocity air and baffles can be used to entrain the spray to a specific area. A wide variety of coatings, chemicals, lubricants, and particulate suspensions can readily be atomized. However, factors such as viscosity, miscibility, and solid content deserve consideration. For optimum atomization, the viscosity should be under 500 cps and the solid concentration kept below 30%. Because the atomization process depends on setting a liquid film into motion, typically the higher the viscosity – the lower the flow rate, and the more difficult the application. The atomization of liquids containing long-chained polymer molecules is problematic, even in diluted form, due to the highly cohesive nature of the material. In many cases, mixtures with particulates can be atomized, because the solids are simply carried along in the drops. The low transport velocity of the liquid through the probe permits even abrasive slurries to be processed with negligible erosion of the passageway. Compared with conventional pressurized nozzles, the feed channel running through the probe and exit orifice are relatively large, and practically uncloggable. Drop size is primarily a function of frequency, and with water, the median drop size at 40 kHz is approximately 50 microns.

* Shown with atomizing probe Part No. 630-0668

HOW DOES IT WORK?

The ultrasonic power supply converts 50/60 Hz to high frequency electrical energy. This electrical energy is transmitted to the piezoelectric transducer within the converter, where it is changed to mechanical vibrations. The ultrasonic vibrations are intensified by the probe and focused at the tip where the atomization takes place. The liquid travels through the probe and spreads out as a thin film on the atomizing surface. The oscillating tip disintegrates the liquid into micro-droplets, and ejects them to form a gentle, low velocity spray.

SPECIFICATIONS

POWER SUPPLY	Net power output: 130 Watts. Frequency: 40 kHz (Model No. VCX 134 ATDP) Dimensions: (H x W x D): 4½" x 9¾" x 12½" (115 x 250 x 320 mm) Weight: 7 lbs. (3 kg)
FEED-THROUGH CONVERTER	Piezoelectric lead zirconate titanate crystals (PZT) 40 kHz - Part No. CV 249. Diameter: 1¼" (32 mm) Length: 4 ⁹ / ₃₂ " (108 mm) Weight: 6 ounces (170 grams) Cable length: 5' (1.5 m)
ATOMIZING PROBE*	Titanium alloy Ti-6Al-4V. Autoclavable. 40 kHz: 630-0667, or 630-0668
MEDIAN DROP SIZE	40 kHz: 50 microns
TUBING REQUIRED	¾" (5 mm) inside diameter.
ELECTRICAL REQUIREMENTS	Unless otherwise requested, units are shipped wired for 117 volts, 50/60 Hz. For export please specify desired voltage options.

40 kHz ATOMIZING PROBES

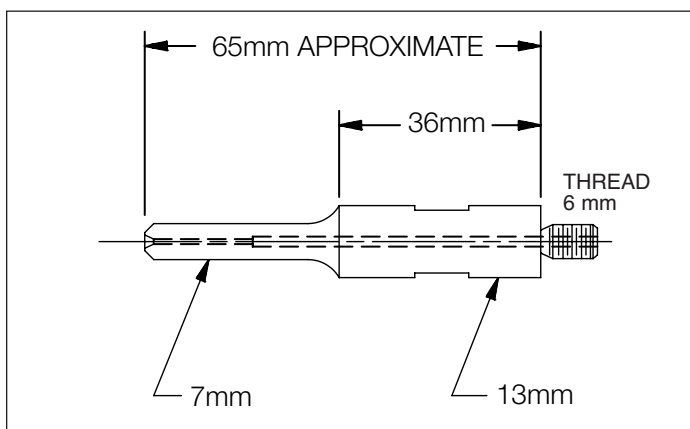

Narrow spray tip
Low atomization rate. Up to 30 ml./min.
Part No. 630-0667

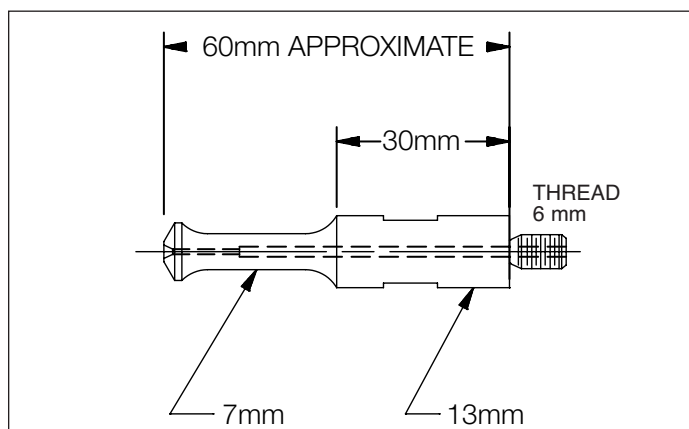

Wide spray tip
Medium atomization rate. Up to 50 ml./min.
Part No. 630-0668

Note: Because ultrasonic probes are tuned to resonance, their lengths may vary slightly due to variations in the titanium's modulus of elasticity.

ORDERING INFORMATION

Model No.

130 Watt ultrasonic atomizer 40 kHz VCX 134 ATDP

* Please specify probe part number. Unless otherwise specified, the atomizer will be shipped with atomizing probe Part No. 630-0667.

Note: Shipped complete and ready for operation with an atomizing probe, two wrenches Part No. 888-00026 and Part No. 888-00035, and instruction manual.

ATOMIZERS FOR HIGH ATOMIZATION RATE

With the dual inlet probe the mixed liquids flow through the probe and spread out as a thin film on the tip surface. The oscillations disintegrate the liquid into micro-droplets and eject them to produce a fine, low velocity spray. One port can be sealed when only one liquid has to be processed. Threaded inlet ports #10-32 UNF thread. Use with $\frac{5}{32}$ " (4 mm) inside diameter tubing.

Atomization can be continuous or intermittent. The probe is fabricated of titanium alloy Ti-6Al-4V and is autoclavable.



DUAL INLET
ATOMIZING PROBE
20 kHz

DUAL INLET ATOMIZING PROBE

	20 kHz DUAL INLET ATOMIZING PROBE
PART NO.	630-0434
COMPATIBLE WITH	VCX 130 FSJ
CONVERTER	CV 18
MAX. FLOW RATE*	100 ml/minute
MEDIAN DROP SIZE	90 microns

* With water

ORDERING INFORMATION

Model No.

130 Watt ultrasonic atomizer with dual inlet atomizing probe – 20 kHz VCX 130 AT

ULTRASONIC PROCESSORS FOR OEM APPLICATIONS

Sonics is structured to serve the OEM market, and over the years we have accumulated more experience working with OEM applications than all other ultrasonic companies combined.

For most applications we have at our disposal a wide selection of proven products – from 50 watts to 1500 watts, designed specifically for the OEM market. They are readily available, and cost effective. In addition, we can provide –application-specific variations of our core products to suit unique requirements.

Our engineers are among the most knowledgeable in the field of ultrasonics, and they typically devote as much time working collaboratively with our customers, as they do in our plant, designing and refining new products. Their involvement with a variety of critical projects has compelled us to develop robust equipment that can withstand the rigors of industrial environment, establishing our company as the supplier of choice for demanding ultrasonic applications.

At Sonics we recognize that it is the varying needs of our customers that set the agenda for innovative product development. We welcome the opportunity to solve complex problems, and undertake challenging projects with optimism and enthusiasm. So, if you want to explore how the inclusion of ultrasonics can benefit your process or application, please feel free to contact a member of our technical staff. We have a high regard for privacy, and your needs will be assessed confidentially, without obligation or preconceived solutions . . . just customized alternatives to address your particular requirements.



OEM ULTRASONIC KIT BOARDS*



50 WATT BOARD
(with mounting plate)

Overall dimension: 4.75" (120.7mm) W x
4.75" (120.7mm) L x 2.2" (56mm) H

4 Mounting holes - .200" (5mm):
2.75" (70mm) x 3.45" (88mm)

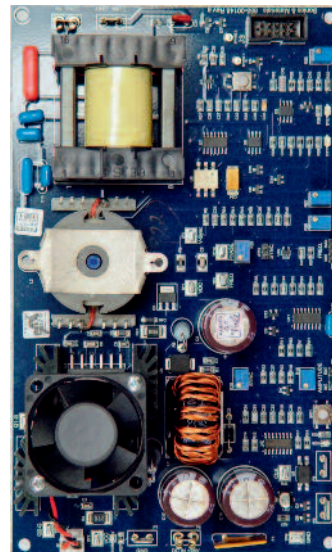

100 WATT BOARD

Overall dimension: 4.5" (114.3mm) W x
7.5" (190.5mm) L x 2.2" (56mm) H

4 Mounting holes - .156" (3.96mm):
4.2" (106.68mm) x 7.2" (182.88mm)

ORDERING INFORMATION

	Part No. (20 kHz)	Part No. (40 kHz)
50 Watt Ultrasonic Kit BoardKITVC522	KITVC544
100 Watt Ultrasonic Kit BoardKITVC1022	KITVC1044

* Boards, converters, cables and probes are sold separately.

FREQUENTLY ASKED QUESTIONS

What is ultrasonics?

Although sound is the sensation perceived by the sense of hearing, it's not always audible. Ultrasound literally means beyond sound; sound above the human audible spectrum. The frequency of a sound is the number of cycles of a sound wave in one second. Frequency is measured in units called hertz (Hz). Since 18 kHz (18,000 Hertz/cycles) per second is the approximate upper limit of human audibility, ultrasonics refers to sound (acoustic waves) beyond that frequency.

What are the differences between an ultrasonic processor and an ultrasonic bath?

The intensity within a bath is fixed, low, location dependent, and inconsistent, due to the fluctuation in the level and temperature of the water.

With an ultrasonic processor, processing is significantly faster and highly reproducible, due to the fact that the energy at the probe tip is high (at least 100 times higher than that produced in a bath), focused and adjustable.

20 kHz or 40 kHz?

40 kHz is commonly used for ultrasonic atomization because the droplet size at that frequency is half that generated at 20 kHz. However, the frequency of choice for most ultrasonic liquid processing applications is 20 kHz, because the amplitude at the probe tip and the resulting cavitation is twice that generated at 40 kHz.

With ultrasonic processing, are there any limitations?

Yes. Viscosity, temperature and liquid characteristics.

As the viscosity of the material increases, its ability to transmit vibrations decreases. Typically, the maximum viscosity at which a material can be processed effectively is 4000 cps. With standard systems, the practical upper limit on temperature without air cooling is approximately 100°C. Solid probes can safely be used with both aqueous solutions and low surface tension liquids (e.g. solvents), however, probes with replaceable tips should **never** be used with samples containing low surface tension liquids.

Which instrument should I use?

The 500 and 750 watt units are the most versatile because they can process both large and small volumes – on a batch basis, as little as 250 µl with a microtip, and as much as 1 liter with a 1" (25 mm) probe. Additionally, they can process up to 30 liters per hour on a flow-through basis when used with a medium volume continuous flow cell.

Since every instrument will perform equally well up to a certain volume, for samples up to 150 ml, the 130 watt models might warrant consideration.

The 1500 watt unit is the unit of choice for scale up and industrial applications.

Which probe is best suited for my application?

The larger the probe diameter, the larger the volume that can be processed, but at lesser intensity. See probe listings for recommendations; and for dependable performance, **always** use a solid probe when processing samples containing organic solvents or low surface tension liquids.

Can probes be manufactured to any length?

No. Probes are made to resonate at a specific frequency (half a wavelength or multiple of half wave lengths). 20 kHz probes are approximately 5" (127 mm) long and can be made longer in 5" (127 mm) increments. 40 kHz probes are approximately 2.5" (63 mm) long and can be made longer in 2.5" (63 mm) increments. Because ultrasonic probes are tuned to resonance, it is not uncommon for probes of identical frequency to have slightly different lengths due to variations in the titanium's modulus of elasticity.

Do all manufacturers rate the power output capabilities of their ultrasonic processors the same way?

Unfortunately not. Sonics' units are rated using the RMS standard – the amount of power, measured in watts, that a unit is capable of delivering continuously. Some of our competitors use less conservative methods, such as measuring the power for only a short period of time.

TYPICAL APPLICATIONS

CELL BIOLOGY

- Cell lysis
- Tissue disruption
- Tissue homogenization
- Plasma extraction

GENOMICS

- RNA extraction
- DNA shearing
- Chromatin shearing

CHEMISTRY/SAMPLE PREPARATION/PHARMACEUTICAL

- Compound formulation
- Compound dissolution
- Tablet disaggregation
- Emulsion
- Liposome preparation
- Particle size reduction
- Nanoemulsion
- Nano-scale dispersion
- Sonochemistry
- Degassing
- Intense cleaning
- Botanical oil extraction



Sonics' worldwide headquarters and manufacturing facility in Newtown, Connecticut, USA

All information and specifications in this catalog were reviewed for accuracy at the time of printing. Because of our policy of continual improvement, we reserve the right to change our products at any time without prior notice, in order to optimize performance and reliability. For the latest information, please contact one of our Product Specialists.

NEED
ADDITIONAL
INFORMATION?

For technical assistance, to request a quotation or inquire about delivery, please call toll free 1-800-745-1105 or 203-270-4600.

HOURS:

Monday through Friday between 8:30 am and 4:30 pm
(Eastern Standard Time)

ORDER BY:

PHONE:

Toll free 1-800-745-1105 or 203-270-4600

FAX:

203-270-4610

MAIL:

Sonics & Materials, Inc.
53 Church Hill Road
Newtown, CT 06470-1614 USA

EMAIL:

info@sonics.com

WEB SITE:

www.sonics.com

WORLDWIDE
DISTRIBUTION
WITH SUPPORT AT
THE LOCAL LEVEL

Represented by: